



AHŞAP YAPI VE MALZEMELERİ

AHŞAP EV KATALOĐU

www.doruyapi.com

www.rnbdoruconstruction.com





İÇERİK

03

HAKKIMIZDA

04

FARK YARATAN
ÖZELLİKLERİMİZ

05

AHŞAP EV
MODELLERİ

29

KURULUM
ŞEMASI

33

YARDIMCI
AHŞAP
PROFİLLER

38

AHŞAP
PERGOLA
SİSTEMLERİ

39

KAPI PENCERE
MODELLERİ

40

MUTFAK
BANYO
DOLAP
KAPAK
MODELLERİ

41

ÇATI VE TEMEL
DETAYLARI

42

KORKULUK
MODELLERİ

43

RENK
KARTELASI

44

SERTİFİKALAR

HAKKIMIZDA

RNB Doru Yapı, 1900'ü yılların başında tomrukçuluk ve marangozluk yapan Sait Yazıcı'nın ahşap sevgisi ve ustalığını sonraki nesillere aktarmasıyla filizlenen mirasın 4. kuşak temsilcileri tarafından 2014 yılında kurulmuştur.

5 nesile dayanan köklü ahşap işleme tecrübesini, modern mimari teknikler, malzeme kalitesi ve kusursuz işçilik ile birleştiren RNB Doru Yapı; geliştirdiği yenilikçi çözümlerle modüler ahşap ev ve ahşap yapı malzemeleri üretiminde kişiye özel ya da proje bazlı anahtar teslim hizmet sunan **"Alanında Tek"** ahşap yapı firmasıdır.

%100 doğal ahşap malzemeler kullanarak doğaya saygılı, sağlıklı, estetik ve sürdürülebilir yaşam alanları üretme felsefesiyle yola çıkan RNB Doru Yapı, uzman kadrosu, son teknoloji makine parkuru, kalite ve müşteri odaklı hizmet anlayışı ile yurtiçi ve yurtdışında fark yaratan öncü projelere imza atmaya devam etmektedir.



Sait Yazıcı - 1920'li yıllar

NELER YAPIYORUZ

İskandinav dağ evlerinden ilham alan mimarisiyle 4 mevsim yaşam imkanı sunan, kolay montajı ve her zevke hitap eden seçenekleriyle anahtar teslim ahşap ev modelleri.

Ticari kullanıma yönelik sosyal tesis, kafe, restoran, otel vb. anahtar teslim proje taahhüt hizmetleri.

Ahşap yapılar için inovatif çözümler sunan, ekstra yalıtımlı, geniş renk seçenekleriyle ahşabın tüm güzelliğini ortaya çıkaran dokulu ve eskitme yüzeye sahip modüler ahşap yapı malzemeleri üretimi.

Satış sonrası iç mimari, bakım ve montaj hizmetleri.



FARK YARATAN ÖZELLİKLERİMİZ



Modüler Sistem

Uzun ARGE çalışmaları sonucu geliştirdiğimiz birbirine geçmeli, kilitli sistem ahşap paneller ile standart ev modellerimize ek olarak her ihtiyaca cevap veren birçok farklı alternatif üretebiliyoruz.



Kolay Montaj

Geliştirdiğimiz modüler sistem sayesinde her ev modeli; 2 kişiyle bir haftada, ekiple birlikte 1 günde kurulabiliyor.



Dokulu Ahşap

Doğal tekniklerle ahşabın organik dokusunu ortaya çıkararak ilk 20 yıl içerisinde çürüyecek olan katmanını temizliyoruz. Böylece dış etkenlere karşı ahşabın ömrünü uzatırken; dış cephe ve iç mekanlara estetik bir görünüm kazandırıyoruz.



Özel Formül Boya

Özel geliştirdiğimiz ve el işçiliği ile uygulanan emprenye katkılı boya; antibakteriyel, sağlığa zararlı ağır metal içermeyen yapısı ile ekstra koruma sağlıyor.



Etkin İzolasyon

İçerisinde yalıtım levhası bulunan lamine ahşap panel tasarımı, zeminde taş yünü uygulaması, Isıcam marka yalıtımlı cam üniteleri ve çatı kaplaması ek bir işlem gerektirmeden 4 mevsim kullanım için etkin ses ve ısı yalıtımı sunuyor.



İnovatif Temel Sistemi

Geliştirdiğimiz kazık temel sistemi sayesinde, beton ve ek donatıya ihtiyaç duymadan her türlü arazi tipine kolaylıkla uygulanabilen sağlam temel uygulamaları yapabiliyoruz.



Dayanıklılık

Ev modellerimizde, ideal seviyede kurulum derecesine sahip fırınlanmış ahşap ürünleri kullanarak kurtlanma, haşere ve mantarın önüne geçiyor; doğru bakımla yüz yıllar boyunca ayakta kalacak sağlıklı yaşam alanları inşa ediyoruz.



Deprem Dayanımı

Kilitli sistem panellerden oluşan ahşap duvarlar ve ahşap iskelet sistemi, taşıyıcı görevi üstlenerek depreme karşı betonarme yapılara göre 5 kat fazla dayanım gösteriyor.



Yangın Direnci

Özel geliştirdiğimiz emprenye katkılı boya ve ahşap duvar panelleri içerisinde kullandığımız yanmaz yalıtım levhası alev geciktirici özelliğiyle yangına karşı maksimum direnç gösteriyor.

SEDİR



91,9 m² yaşam alanı



ÖRNEK İÇ MEKAN GÖRSELLERİ



ÖRNEK KAT PLANI

ZEMİN KAT PLANI



MUTFAK / SALON	32.1 m ²
YATAK ODASI	12.5 m ²
BANYO / WC	4.3 m ²
ÇATI ALTI VERANDA	12.7 m ²
TOPLAM	61.6 m²

ASMA KAT PLANI



YATAK ODASI	10.8 m ²
YATAK ODASI	10.8 m ²
HOL	8.7 m ²
TOPLAM	30.3 m²

GÖKNAR



83 m² yaşam alanı

ÖRNEK İÇ MEKAN GÖRSELLERİ

ÖRNEK KAT PLANI



ZEMİN KAT PLANI

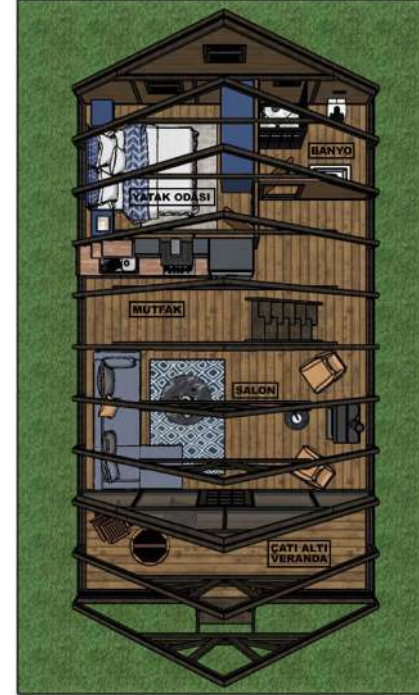

ASMA KAT PLANI

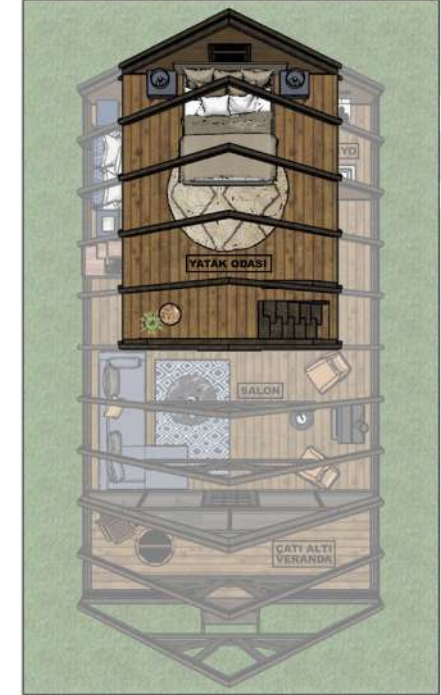

MUTFAK / SALON	32.4 m ²
YATAK ODASI	11.3 m ²
BANYO / WC	5.2 m ²
ÇATI ALTI VERANDA	12.7 m ²
TOPLAM	61.6 m²

YATAK ODASI	21.4 m ²
TOPLAM	21.4 m²

DEFNE



 **60,7 m² yaşam alanı**

ÖRNEK İÇ MEKAN GÖRSELLERİ

ÖRNEK KAT PLANI



ZEMİN KAT PLANI



ASMA KAT PLANI



MUTFAK / SALON	35.7 m ²
BANYO / WC	4.2 m ²
ÇATI ALTI VERANDA	5.3 m ²
TOPLAM	45.2 m²

YATAK ODASI	15.5 m ²
TOPLAM	15.5 m²

LADİN



🏠 63.5 m² yaşam alanı



ÖRNEK İÇ MEKAN GÖRSELLERİ

ÖRNEK KAT PLANI



ZEMİN KAT PLANI

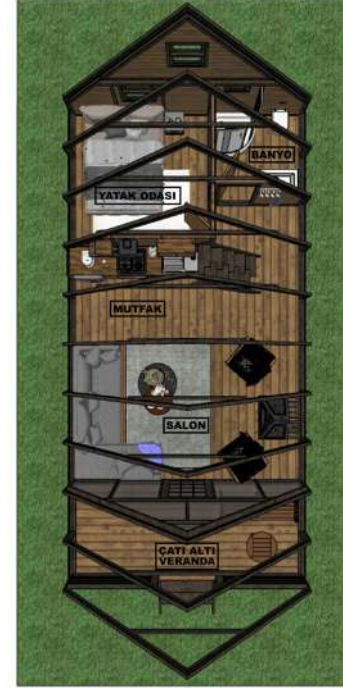

ASMA KAT PLANI



MUTFAK / SALON	26.6 m ²
YATAK ODASI	9.2 m ²
BANYO / WC	4.2 m ²
ÇATI ALTI VERANDA	10.2 m ²
TOPLAM	50.2 m²

YATAK ODASI	13.3 m ²
TOPLAM	13.3 m²

ÇAM



🏠 53.5 m² yaşam alanı

ÖRNEK İÇ MEKAN GÖRSELLERİ



ÖRNEK KAT PLANI

ZEMİN KAT PLANI

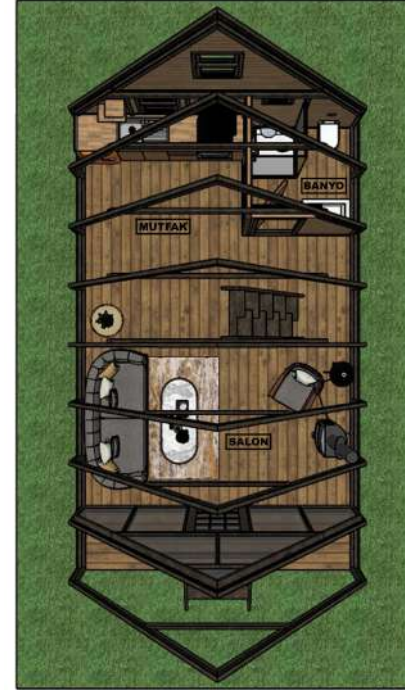

ASMA KAT PLANI

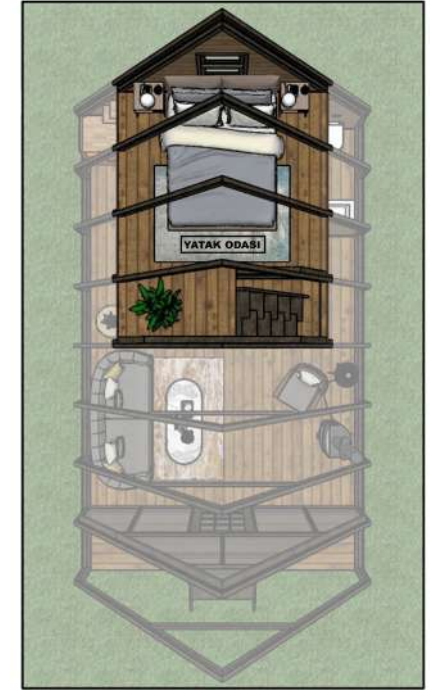

MUTFAK / SALON	30.7 m ²
BANYO / WC	4.2 m ²
ÇATI ALTI VERANDA	5.3 m ²
TOPLAM	40.2 m²

YATAK ODASI	13.3 m ²
TOPLAM	13.3 m²

ARDIÇ



43.5 m² yaşam alanı



ÖRNEK İÇ MEKAN GÖRSELLERİ

ÖRNEK KAT PLANI



ZEMİN KAT PLANI



ASMA KAT PLANI



MUTFAK / SALON	24.5 m ²
BANYO / WC	4.2 m ²
ÇATI ALTI VERANDA	1.5 m ²
TOPLAM	30.2 m²

YATAK ODASI	13.3 m ²
TOPLAM	13.3 m²

KESTANE



 32.2 m² yaşam alanı



KESTANE

ÖRNEK İÇ MEKAN GÖRSELLERİ



ÖRNEK KAT PLANI



MUTFAK / SALON	18.4 m ²
BANYO / WC	4.6 m ²
YATAK ODASI	8 m ²
ÇATI ALTI VERANDA	1.2 m ²
TOPLAM	32.2 m²

SELVİ



 **26.1 m² yaşam alanı**



ÖRNEK İÇ MEKAN GÖRSELLERİ



ÖRNEK KAT PLANI

ZEMİN KAT PLANI



MUTFAK / SALON	15.2 m ²
BANYO / WC	5.3 m ²
TOPLAM	20.5 m²

ASMA KAT PLANI



YATAK ODASI	5.6 m ²
TOPLAM	5.6 m²

HOBBİT



 25.3 m² yaşam alanı



ÖRNEK İÇ MEKAN GÖRSELLERİ

ÖRNEK KAT PLANI



SALON	13.4 m ²
BANYO / WC	4.3 m ²
YATAK ODASI	6.1 m ²
ÇATI ALTI VERANDA	1.5 m ²
TOPLAM	25.3 m²

BAMBU



 **24.2 m² yaşam alanı**

BAMBU

ÖRNEK İÇ MEKAN GÖRSELLERİ



ÖRNEK KAT PLANI



YATAK ODASI	16.2 m ²
BANYO / WC	8 m ²
TOPLAM	24.2 m²

SIĞLA



21.2 m² yaşam alanı



ÖRNEK İÇ MEKAN GÖRSELLERİ

ÖRNEK KAT PLANI



MUTFAK / SALON	15.5 m ²
BANYO / WC	4.3 m ²
ÇATI ALTI VERANDA	1.4 m ²
TOPLAM	21.2 m²

MEŞE



🏠 18.3 m² yaşam alanı



ÖRNEK İÇ MEKAN GÖRSELLERİ



ÖRNEK KAT PLANI



YATAK ODASI	12.3 m ²
BANYO / WC	6 m ²
TOPLAM	18.3 m²

KURULUM ŐEMASI

1

Metal ayakların ve temel kazıklarının montajı yapılır. Temel dış ve ara bağlantılar kurulur.

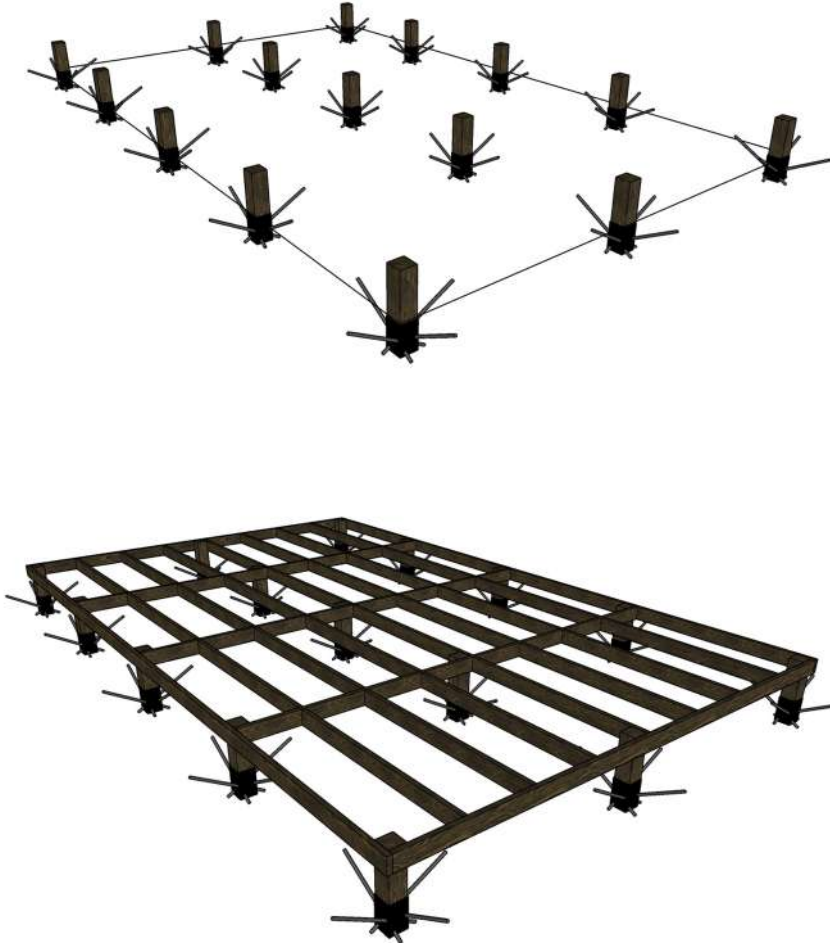

2

İlk ana taşıyıcı çerçevesi kurulur ve yerine kurulur. Bir sonraki çerçeve montajı yapılmadan önce arasına lento konur ve sonrasında çerçeve montajı yapılır.



KURULUM ŐEMASI

3

Dış yalıtımlı lamine duvar döşenir. Sırasıyla lento , ana taşıyıcı ve yalıtımlı lamine duvarlar döşenerek iskelet montajı tamamlanır.



4

İlk arka çerçeve montajı yapılır. Sonrasında ön çerçeve montajı yapılır.



KURULUM ŐEMASI

5

Çatı altı ıtalarn ve yan kapamaların montajı yapılır.
Çatıya yalıtımlı sac panel , çatı ve alın mahyaları ve eksiz galvaniz dere montajları yapılır.



6

Zemin kat ve asma kat yalıtımlı ahşap lamine ile döşenir.
Ara banyo duvarı ve merdiven montajı yapılır.

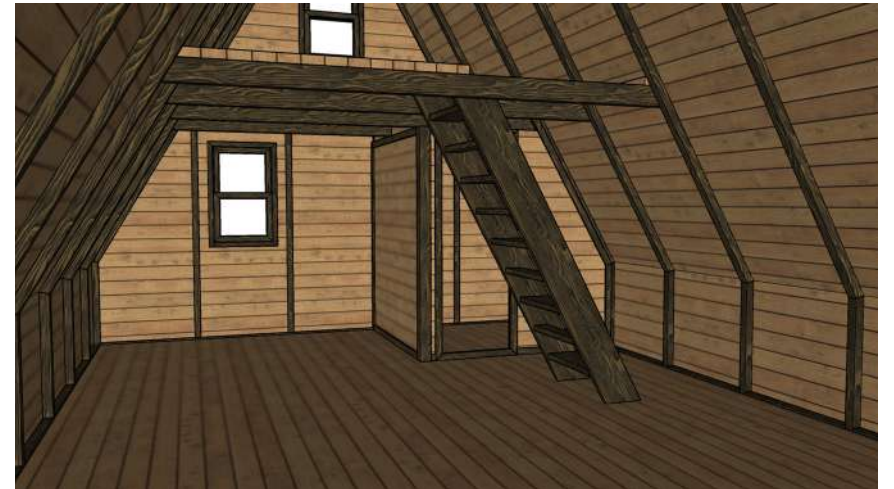

KURULUM ŐEMASI

7

Mutfak dolabı , banyo dolabı , i oda kapısı , dıŐ kapı ve asma kat korkuluk montajları yapılır.



8

Aık olan n kısma ahŐap deck dŐenir. En son ereve ve kapı camları takılıp ahŐap ev montajı tamamlanır.



YARDIMCI ÜRÜNLER

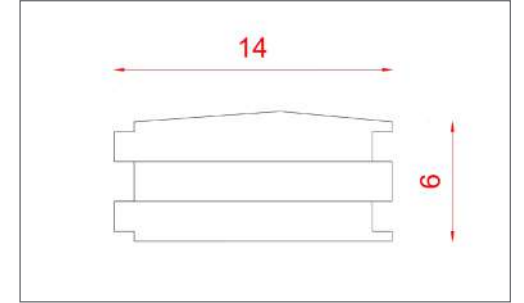
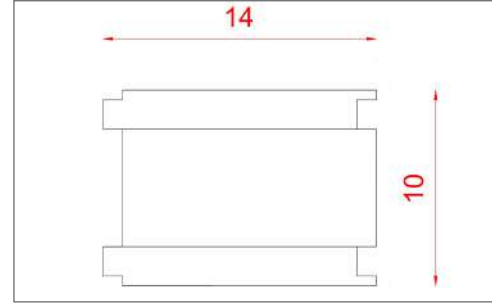
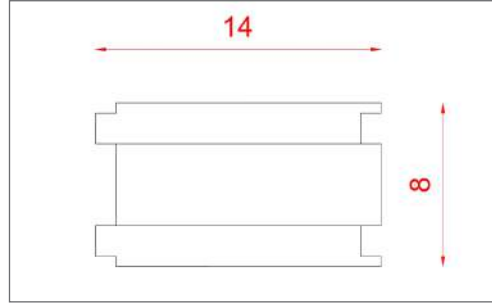
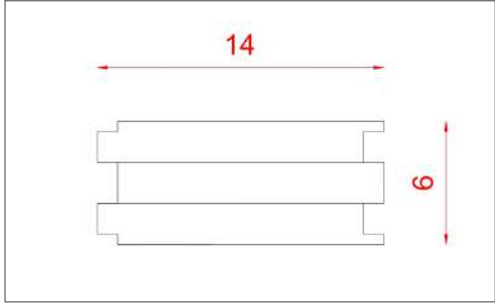
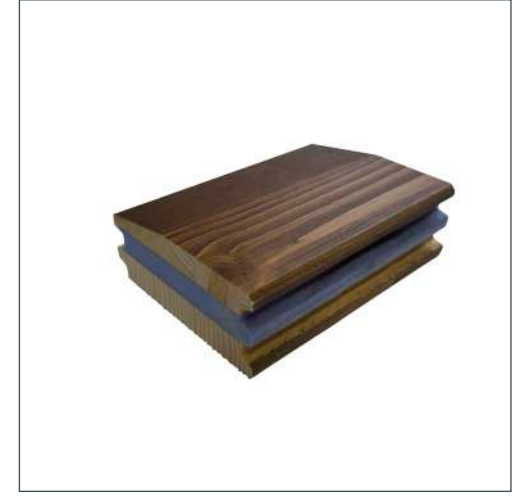

YARDIMCI ÜRÜNLER

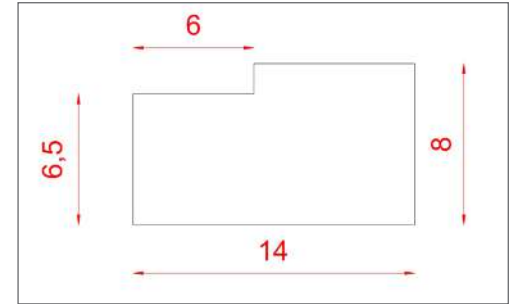
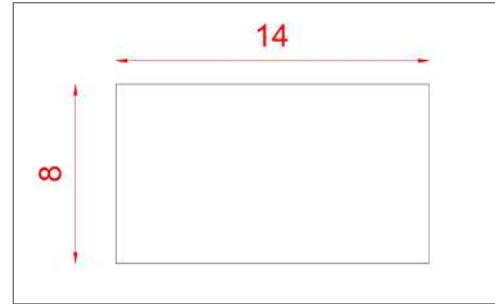
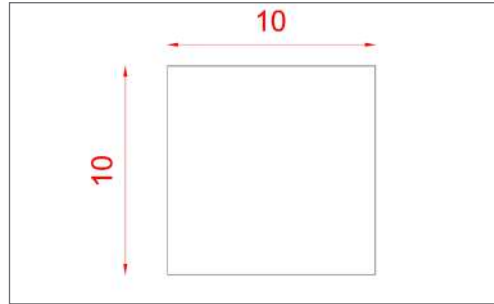
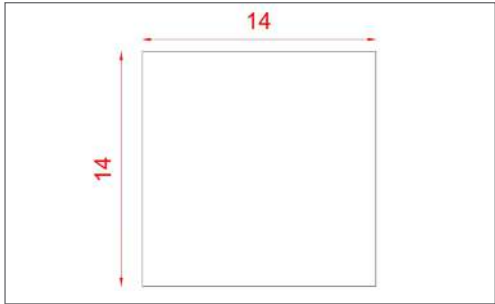

YARDIMCI ÜRÜNLER

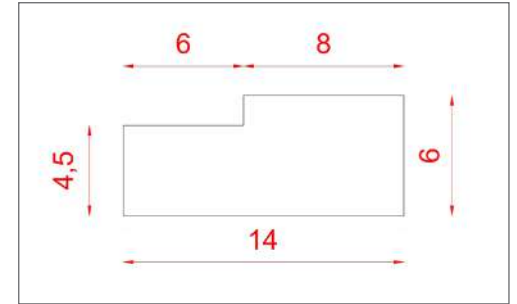
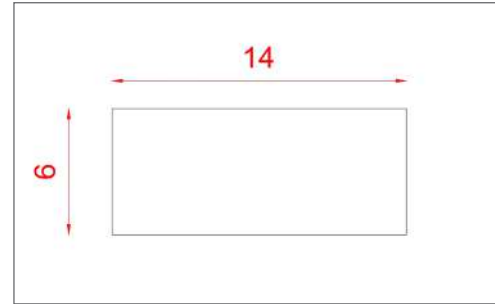
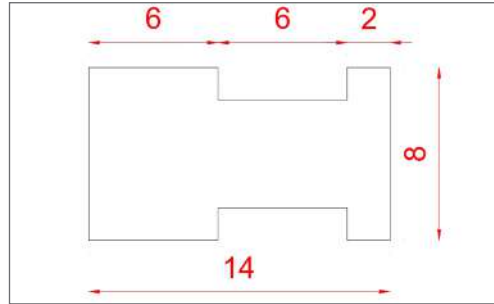
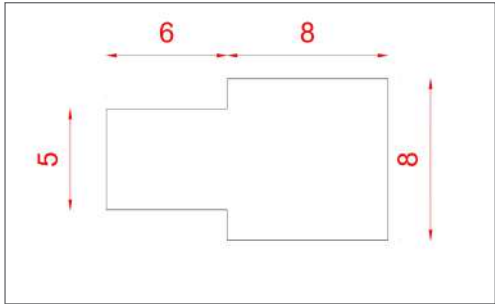

YARDIMCI ÜRÜNLER

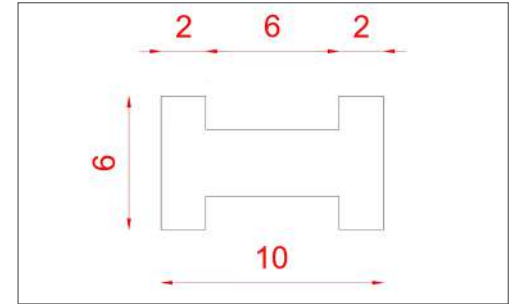
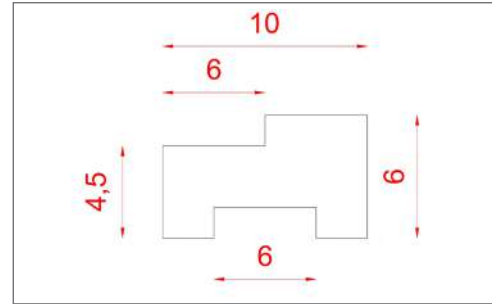
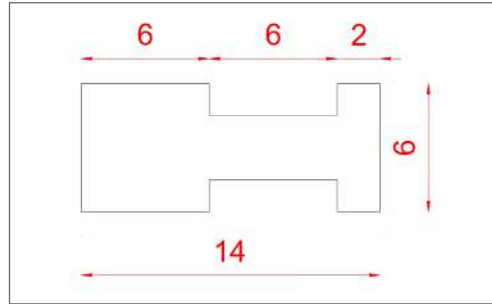
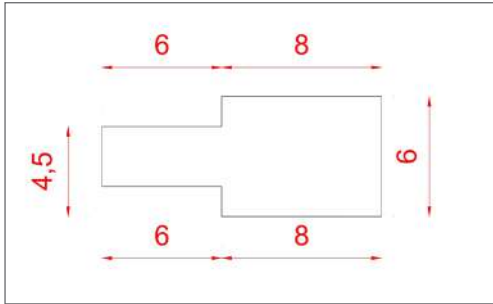

YARDIMCI ÜRÜNLER

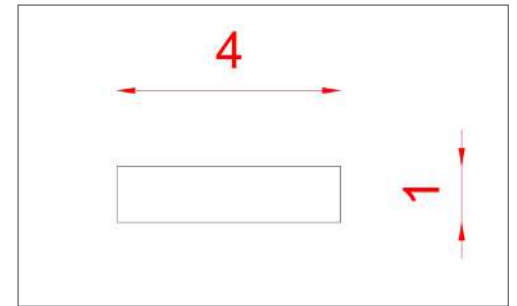
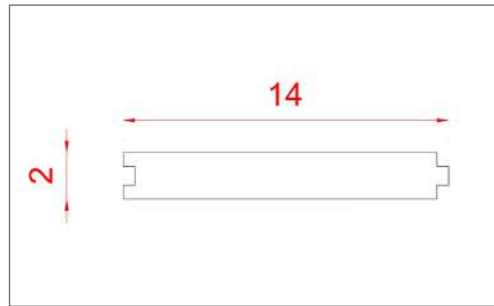
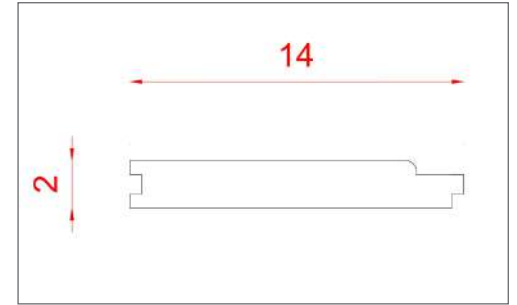
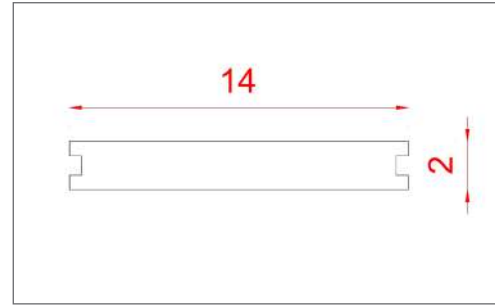
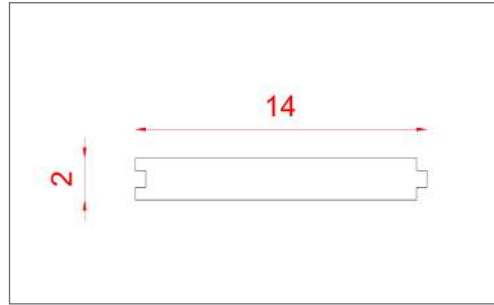
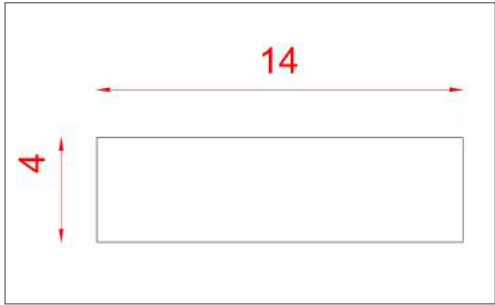

AHŞAP PERGOLA SİSTEMLERİ

PERGOWOOD

- Modüler Sistem
- Kolay Montaj
- Sınırsız Uygulama Seçeneği
- Dokulu Lamine Yüzey
- Özel Formül Boya
- Dayanıklı Malzeme
- Estetik Görünüm



KAPI PENCERE MODELLERİ

KAPI MODELLERİ



PENCERE MODELLERİ



* İ kapı yüzeyleri Mdfkap (MDF üzeri ağısap masif kaplama) malzemedendir.

MUTFAK - BANYO DOLAP KAPAK MODELLERİ

MUTFAK DOLAP KAPAKLARI



BANYO DOLAP KAPAKLARI



* Mdfkap (MDF üzeri ahşap masif kaplama) malzemedendir.

ÇATI ve TEMEL DETAYLARI

ÇATI DETAYI



TEMEL DETAYI

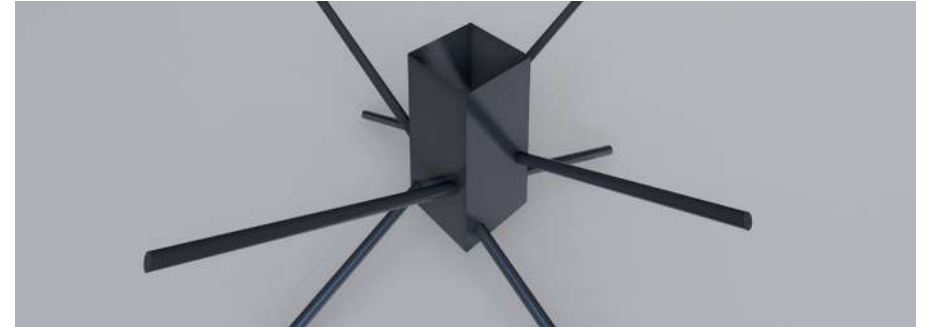
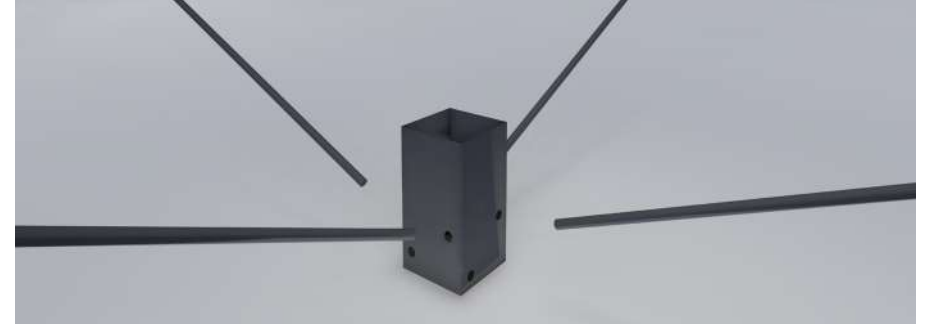

KORKULUK MODELLERİ

MODEL 1



MODEL 2



MODEL 3



RENK KARTELASI - EMPRENYELİ RENKLER

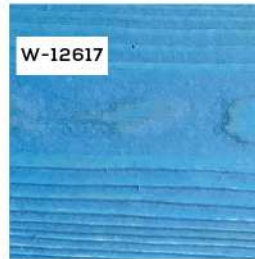
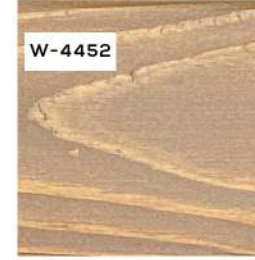
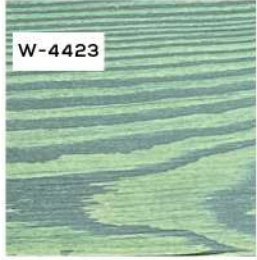
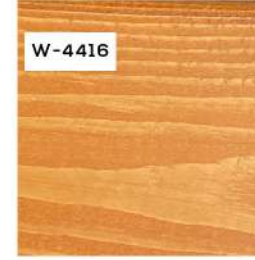
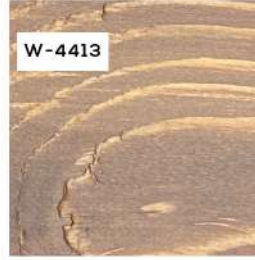
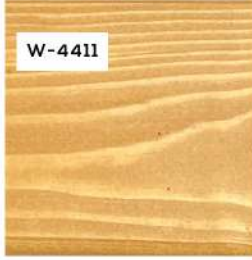

Renkler baskılı ve dijital kataloglarda farklılık gösterebilir. Lütfen gerçek ürünlerle karşılaştırınız.



Adres: Hacı Yusuf Mah.Mezbaha Sok. No:10/A 10200
Bandırma/ Balıkesir/ TÜRKİYE **Tel:** +90 532 280 00 81
Mail: Info@doruyapi.com

 doruconstruction

 rnbdoruconstruction
doruyapi

